



Cooper
stairworks

STAIRPARTS

www.cooperstairworks.com

COOPER STAIRPARTS STOCK BOX NEWELS

Used with any of our rail or balusters, Cooper Box Newels give any stair system a classic and solid look. Beautifully crafted, Cooper Box Newels are all solid & made of the finest oak, poplar, mahogany or maple. In addition to our stock box newels, our skilled craftsman can create a custom box newel to your specifications, not limited in size and wood specie.



BOX NEWEL PACKAGING



Each end of the post has a custom fitted protective cap that suspends newel in box. Our double wall corrugated cardboard boxes enable us to safely ship our newels and assure they arrive in perfect condition.



COOPER STAIRPARTS STOCK BOX NEWELS

ALL NEWELS ARE SOLID

Part #	Description	Size
Cooper Custom Capped 3-1/2" Newels		
4076BD	Custom capped newel with bead	3-1/2" x 54"
		3-1/2" x 60"
		3-1/2" x 72"
4076CH	Custom capped newel chamfered	3-1/2" x 54"
		3-1/2" x 60"
		3-1/2" x 72"
4076FL	Custom capped newel fluted	3-1/2" x 54"
		3-1/2" x 60"
		3-1/2" x 72"
Cooper Custom Box 4-1/2" Newels		
4092BD	Custom box newel with bead	4-1/2" x 54"
		4-1/2" x 60"
		4-1/2" x 72"
4092FL	Custom box newel fluted	4-1/2" x 54"
		4-1/2" x 60"
		4-1/2" x 72"
4092RP	Custom box newel raised panel	4-1/2" x 54"
		4-1/2" x 60"
		4-1/2" x 72"
4092RRP	Custom box newel raised panel round	4-1/2" x 54"
		4-1/2" x 60"
		4-1/2" x 72"
4092RCP	Custom box newel recessed panel	4-1/2" x 54"
		4-1/2" x 60"
		4-1/2" x 72"
Cooper Custom Box 5-1/2" Newels		
4093BD	Custom box newel with bead	5-1/2" x 54"
		5-1/2" x 60"
		5-1/2" x 72"
4093FL	Custom box newel fluted	5-1/2" x 54"
		5-1/2" x 60"
		5-1/2" x 72"
4093RP	Custom box newel raised panel	5-1/2" x 54"
		5-1/2" x 60"
		5-1/2" x 72"
4093RRP	Custom box newel raised panel round	5-1/2" x 54"
		5-1/2" x 60"
		5-1/2" x 72"
4093RCP	Custom box newel recessed panel	5-1/2" x 54"
		5-1/2" x 60"
		5-1/2" x 72"
Finial - to be used on both 4-1/2" and 5-1/2" newels.		

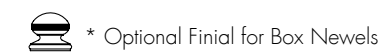
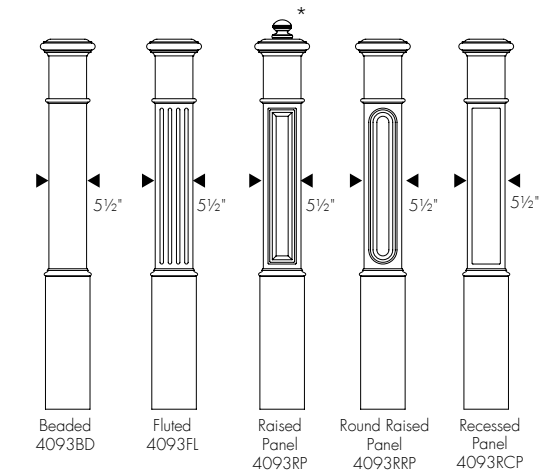
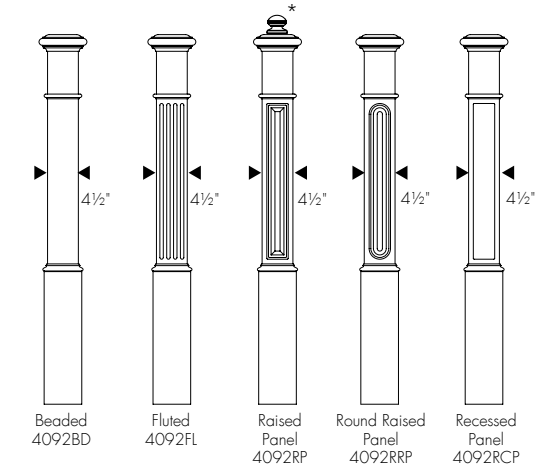
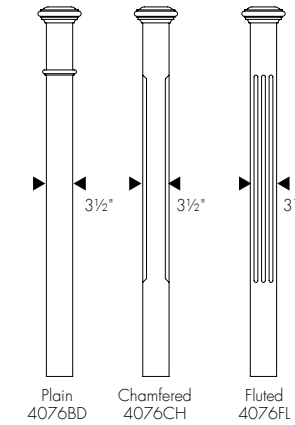

* Optional Finial for Box Newels
◆ Specify in Oak, Poplar, Mahogany and Maple.



**GO AHEAD...
Mix it UP!**
Take a poplar post and mix species for a new look

FOR EXAMPLE
Poplar Post + Mahogany Cap, Cove & Bead = A unique look that will add value to your project.

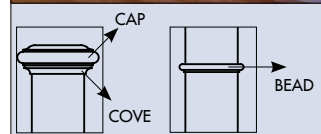

COOPER STAIRPARTS CUSTOM BOX NEWELS











Box Newels are not limited by our stock box newel posts. We are happy to provide a quote on a custom newel post for your application, not limited in size or specie. Go ahead, mix up the species, we love a challenge! We want to make your project stand out from the rest.



LEGACY 6" NEWELS

Part #	Description	Size	Oak	Mah	Map
5013OCT	Octagon	6" x 42"	X	X	X
5013RB	Round	6" x 42"	X	X	X
5013SQ	Square	6" x 42"	X	X	X
501054OCT	Octagon	6" x 54"	X	X	X
501054RB	Round	6" x 54"	X	X	X
501054SQ	Square	6" x 54"	X	X	X

Fittings					
	6008-05	Starting Easement	X	X	X
	6008-42	Turnout LH	X	X	X
	6008-47	Turnout RH	X	X	X
	6009-05	Starting Easement	X	X	X
	6009-42	Turnout LH	X	X	X
	6009-47	Turnout RH	X	X	X
	6014-05	Starting Easement	X	X	X
	6014-42	Turnout LH	X	X	X
	6014-47	Turnout RH	X	X	X

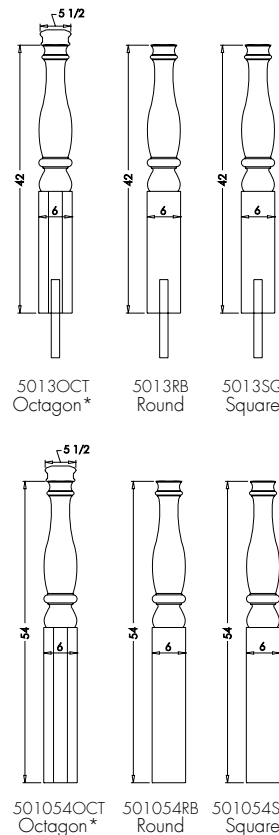

X SPECIAL ORDER

*shown with fitting



COOPER STAIRPARTS BALUSTERS & HAND RAIL

◆ STOCK X SPECIAL ORDER -- NOT AVAILABLE MOST NON-STOCK ITEMS AVAILABLE IN 3-5 DAYS UNLESS NOTED

Part #	Description	Size	Oak	Poplar	SYP
Square Balusters					
5060-36	Square	1-1/4" x 36"	◆	◆	X
5060-42	Square	1-1/4" x 42"	◆	◆	X
5260-36	Square	1-1/2" x 36"	◆	◆	X
5260-42	Square	1-1/2" x 42"	◆	◆	X
5360-36	Square	1-3/4" x 36"	◆	◆	--
5360-42	Square	1-3/4" x 42"	◆	◆	--
Round Base Balusters					
Prime	Prime any size baluster (see back cover for more information on prefinishing)				
Bevel	Bevel end and drill for screw and bung (bung included)				
Pin 12	Insert pin in baluster 1/2" diameter				
Pin 34	Insert pin in baluster 3/4" diameter				



Baluster Options
Pin
Bevel & Drill

5060
5260
5360

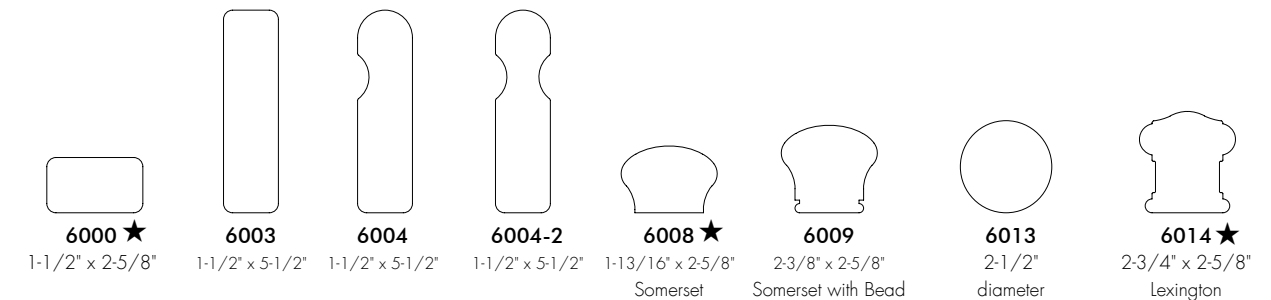

Part #	Description	Size	Oak	SYP	Mahogany	Maple
Handrail - lengths available 4', 6', 8', 10', 12', 14' and 16'						
6000	Contemporary	1-1/2" x 2-5/8"	X	X	X	X
6003	Contemporary	1-1/2" x 5-1/2"	X	X	X	X
6004	Contemporary with 1 finger groove	1-1/2" x 5-1/2"	X	X	X	X
6004-2	Contemporary with 2 finger grooves	1-1/2" x 5-1/2"	X	X	X	X
6008	Somerset	1-13/16" x 2-5/8"	◆ ★	--	◆ ★	◆ ★
6009	Somerset with Bead	2-3/8" x 2-5/8"	◆	--	◆	◆
6013	Round	2-1/2" diameter	X	--	X	X
6014	Lexington	2-3/4" x 2-5/8"	◆	--	◆ ★	◆ ★

Rails available to plow for square top baluster. Specify width.

★ Recommended for use with 1-3/4" balusters. Please call for special items, sizes or species.

◆ STOCK X SPECIAL ORDER -- NOT AVAILABLE

COOPER STAIRPARTS FITTINGS

Fitting diagrams / icons on pages 6 and 7 are used to show function of fitting only and do not depict actual rail profile.
The stairparts in this brochure are made at our factory unless otherwise noted.

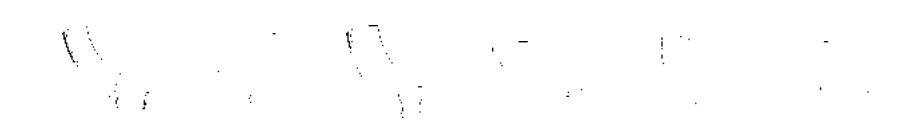

Fittings on this page for use with Cooper Solid NO FINGER JOINTED RAILS

	-10	-11	-12	-13	-14	-19
	starting easing	quarterturn no cap	up easing	over easing	up easing 90°	one opening newel cap

6008	Somerset rail						
	Oak	X	X	X	X	X	X
	Mahogany	X	X	X	X	X	X
	Maple	X	X	X	X	X	X
6009	Somerset rail with bead						
	Oak	X	X	X	X	X	X
	Mahogany	X	X	X	X	X	X
	Maple	X	X	X	X	X	X
6014	Lexington rail						
	Oak	X	X	X	X	X	X
	Mahogany	X	X	X	X	X	X
	Maple	X	X	X	X	X	X
6013	Contemporary rail						
	Oak	X	X	X	X	X	X
	Mahogany	X	X	X	X	X	X

All fittings on this page are made to order

NON RETURNABLE

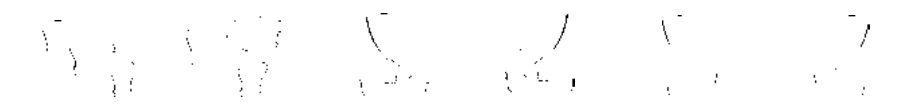

	-20	-21	-30	-35	-40	-45
	tandem cap	quarterturn with cap	LH volute	RH volute	LH turnout	RH turnout

6008						
	Oak	X	X	X	X	X
	Mahogany	X	X	X	X	X
	Maple	X	X	X	X	X
6009						
	Oak	X	X	X	X	X
	Mahogany	X	X	X	X	X
	Maple	X	X	X	X	X
6014						
	Oak	X	X	X	X	X
	Mahogany	X	X	X	X	X
	Maple	X	X	X	X	X
6013						
	Oak	X	X	X	X	X
	Mahogany	X	X	X	X	X

X SPECIAL ORDER

COOPER STAIRPARTS FITTINGS



We are a full stocking dealer of Fitts Stairparts - ask for a Fitts Stairparts Catalog.



COOPER STAIRWORKS GOOSENECKS

Fittings on this page for are made to order NON RETURNABLE

FOR USE WITH COOPER RAILS

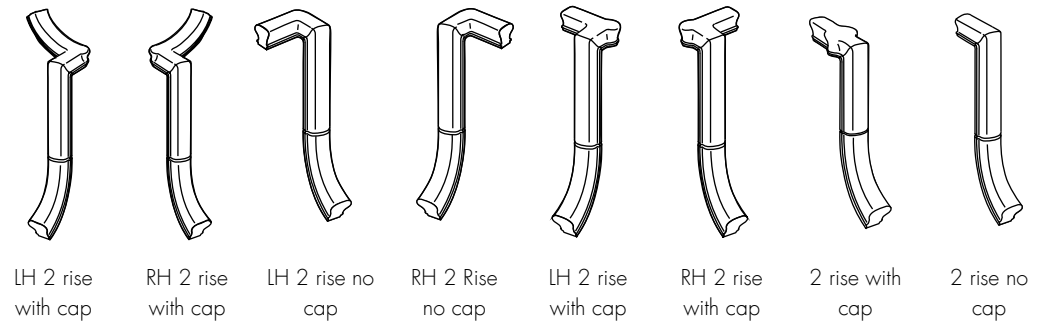

		-60	-65	-71	-76	-81	-86	-89	-99
	LH 2 rise with cap								
	RH 2 rise with cap								
	LH 2 rise no cap								
	RH 2 Rise no cap								
	LH 2 rise with cap								
	RH 2 rise with cap								
	2 rise with cap								
	2 rise no cap								
6008									
	Oak	X	X	X	X	X	X	X	X
	Mahogany	X	X	X	X	X	X	X	X
	Maple	X	X	X	X	X	X	X	X
6009									
	Oak	X	X	X	X	X	X	X	X
	Mahogany	X	X	X	X	X	X	X	X
	Maple	X	X	X	X	X	X	X	X
6014									
	Oak	X	X	X	X	X	X	X	X
	Mahogany	X	X	X	X	X	X	X	X
	Maple	X	X	X	X	X	X	X	X
6013									
	Oak	X	X	X	X	X	X	X	X
	Mahogany	X	X	X	X	X	X	X	X

Most non-stock items available in 3-5 days unless otherwise noted.

X SPECIAL ORDER

COOPER STAIRPARTS ACCESSORIES

Most non-stock items available in 3-5 days unless otherwise noted. ◆ STOCK X SPECIAL ORDER -- NOT AVAILABLE

Part #	Description	Size	Stock	Unit
ORETURN	13" oak return nosing	1-1/32" x 1-1/4" x 13"	◆	each
MRETURN	13" maple return nosing	1-1/32" x 1-1/4" x 13"	◆	each
WRETURN	13" white oak return nosing	1-1/32" x 1-1/4" x 13"	◆	each
OLAND116	Oak landing tread	1-1/16" x 4-1/4"	◆	LF
MLAND116	Maple landing tread	1-1/16" x 4-1/4"	◆	LF
PLAND116	SYP landing tread	1-1/16" x 4-1/4"	◆	LF
OLAND34	Oak landing tread	3/4" x 4-1/4"	◆	LF
OLAND512	Oak landing tread	1-1/16" x 5-1/2"	◆	LF
MLAND512	Maple landing tread	1-1/16" x 5-1/2"	◆	LF
JLAND512	Jatoba landing tread	1-1/16" x 5-1/2"	◆	LF
WLAND512	White Oak landing tread	1-1/16" x 5-1/2"	◆	LF
CLAND512	Cherry landing tread	1-1/16" x 5-1/2"	◆	LF
34512OAK	Oak landing tread	3/4" x 5-1/2"	◆	LF
34512MAP	Maple landing tread	3/4" x 5-1/2"	◆	LF
34512SYP	SYP landing tread	3/4" x 5-1/2"	X	LF
OCOVE	Oak cove	5/8" x 3/4"	◆	LF
VM96	Pine cove	5/8" x 3/4"	◆	LF
MCOVE	Maple cove	5/8" x 3/4"	◆	LF
JCOVE	Jatoba cove	5/8" x 3/4"	◆	LF
WCOVE	White Oak cove	5/8" x 3/4"	◆	LF
CCOVE	Cherry cove	5/8" x 3/4"	◆	LF
MAHCOVE	Mahogany cove	5/8" x 3/4"	◆	LF
HBRK	Brass handrail bracket lves 059		◆	each
HBRKSN	Satin Nickel handrail bracket lves 059-A-92		◆	each
F3001 RBOLTPKG	Rail, bolt, nut and washer	5/16" x 3-1/2"	◆	each
F3000 RPLUG	1" oak plug	1"	◆	each
F3000 RPLUGB	1" beech plug	1"	◆	each
BUNG	3/8" oak bung	3/8"	◆	pkg/25
BUTTON	3/8" oak button	3/8"	◆	pkg/25
F3010 HDBRACKETBB	Brass heavy duty wall rail bracket US-3 finish	2-3/4"	◆	each
F3010 HDBRACKETORB	Oil Rubbed Brass heavy duty wall rail bracket US-10B finish	2-3/4"	◆	each
F3010 BL HDHBRKBL	Black heavy duty wall rail bracket US-19 finish	2-3/4"	◆	each
F3011 UBSWRENCH	Rail bolt wrench		◆	each
F3009 BFKIT	Baluster fastening kit with driver (dowel driver + 4 dowels screws)		◆	each
BFASTENER	2" Dowel Screw with insert		◆	each
F3003	Baluster dowel screws no driver		◆	each
NIKIT	Newel installation kit		◆	each
NPF	Newel plate fastener		◆	each
F3007 NIBRKTKITO	Newel "L" bracket kit with oak trim	3"	◆	each
F3008 NIBRKTKITO312	Newel "L" bracket kit with oak trim	3 1/2"	X	each
F3005 SURETITE	SURE-TITE™	1/2" x 11"	◆	each
FASNFAST	Fas-n-Fast Newel Fastener	2"	◆	each

Rosettes

Part #	Description	Sizes	SYP / Poplar	Oak	Beech	Mahogany	Maple
7007	Cooper Rosette (rectangle)	3-1/4" x 4-3/4"	X	X	-	X	X
7017	Cooper Rosette (round)	4-1/2" diameter	◆	◆	◆	◆	◆
7037	Cooper Rosette (oval)	4" x 5-1/2"	--	◆	◆	◆	◆

ROUND
7017



RECTANGLE
7007



OVAL
7037



BFASTENER



FAS-N-FAST



OLAND34

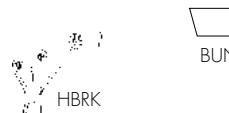

BUTTON

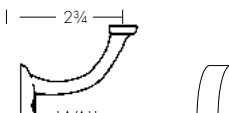

RPLUG



BALUSTER FASTENING KIT

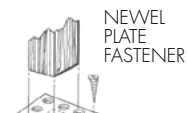

NEWEL PLATE FASTENER



LBRACKET POST FASTENER

SURE-TITE™

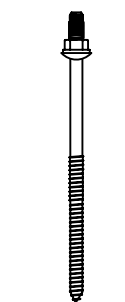

RAIL-BOLT WRENCH

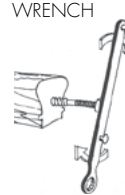

COOPER STAIRPARTS ACCESSORIES

Part #	Description	Stock	Unit
ZIPBOLT™ UT - Railbolt			
ZIPBOLT	ZIPBOLT™ UT Rail Kit 98mm (13.600)	◆	each
ZIPBOLT6P	ZIPBOLT™ UT 6 Pack, 5 Bolts and 1 - 5mm Driver	◆	each
ZIPAK5	ZIPBOLT™ Allen Key 5mm (40.440)	◆	each
ZIPH450	ZIPBOLT™ Hex Driver 4mm x 50mm (40.400)	◆	each
ZIPH5	ZIPBOLT™ Hex Driver 5mm x 50mm (40.410)	◆	each
ZIPH650	ZIPBOLT™ Hex Driver 6mm x 50mm (40.420)	◆	each
ZIPH850	ZIPBOLT™ Hex Driver 8mm x 50mm (40.430)	◆	each
ZIPRD	ZIPBOLT™ Ratchet Driver (40.300)	◆	each
ZIPUTMM685	ZIPBOLT™ UT Half Midi 6mm x 85mm (11.520)	◆	each
ZIPUTMM8135	ZIPBOLT™ UT Maxi Mitre 38mm x 135mm (11.600)	◆	each
ZIPUT8535	ZIPBOLT™ UT 85mm (10.500)	◆	each
ZIPUTMK890	ZIPBOLT™ UT Maxi 8mm x 90mm KD (12.500)	◆	each
ZIPUTAR	ZIPBOLT™ Angled Rail Bolt (11.550)	◆	each
ZIPJIGD	ZIPBOLT™ Drilling JIG D (40.230)	◆	each
ZIPUTD	ZIPBOLT™ Drawbolt Counter Top Fastener (10.900)	◆	each
ZIPUTMINI	ZIPBOLT™ UT Mini 6mm x 100mm (10.800)	◆	each
ZIPUTMIDI690	ZIPBOLT™ UT Midi ST 6mm x 90mm (13.520)	◆	each
ZIPUTMINI643	ZIPBOLT™ UT Mini KD 6mm x 43mm (12.600)	◆	each
ZIPUTMINI630	ZIPBOLT™ UT Mini KD Open Cut 6mm x 30mm (12.601)	◆	each

CALL OR EMAIL FOR LARGER QUANTITIES



EASIER. STRONGER. FASTER.
Gear Driven Rail Bolt

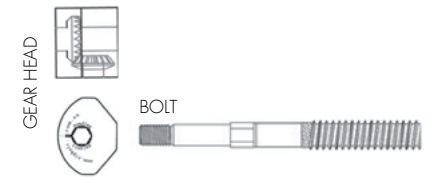

AT LEAST 4 EASY WAYS to tighten the ZIPBOLT UT Rail Bolt



OPTION 1

Ratchet screw driver with 5mm driver.



OPTION 2

Drill with 5mm driver. Start on the lowest torque setting until you find the one that works best.



OPTION 3

5mm "T" handle allen wrench.



OPTION 4

5mm allen wrench

ZIPBOLT™ UT RAILBOLT



13.600

ZIPBOLT™ UT Maxi Mitre



38mm x 135mm

11.600

ZIPBOLT™ Angled Rail Bolt



11.550

ZIPBOLT™ UT Maxi Mitre



38mm x 135mm

11.600

ZIPBOLT™ Drilling JIGD

(40.230)



ZIPBOLT™ Ratchet Driver

(40.300)



ZIPBOLT™ Allen Key 5mm

(40.440)



ZIPBOLT™ UT Mini KD Open Cut



6mm x 30mm

12.601

ZIPBOLT™ UT Mini KD



6mm x 43mm

12.600

ZIPBOLT™ UT 85mm



10.500

ZIPBOLT™ UT Midi ST



6mm x 90mm

13.520

ZIPBOLT™ UT Maxi KD



8mm x 90mm

10.900

ZIPBOLT™ UT Mini

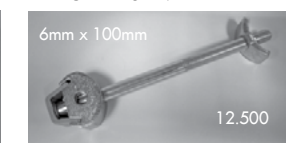

6mm x 100mm

12.500

ZIPBOLT™ Drawbolt Counter Top Fastener



10.800

8mm

6mm

5mm

4mm

COOPER STAIRPARTS STARTING STEPS

◆ STOCK, also stocked in 3/4" tread X SPECIAL ORDER
 Most non-stock items available in 3-5 days unless otherwise noted.

Part #	Description	Size	Oak Tread Paint Grade Riser	Oak Tread Oak Riser	SYP Tread Paint Grade Riser	Maple Tread Paint Grade Riser	Cherry Tread Paint Grade Riser	White Oak Tread Paint Grade Riser	Jotaba Tread Paint Grade Riser
8010	Single bullnose	48" ★	◆	◆	X	X	X	X	X
8030	Single bullnose half circle	48" ★	X	X	X	X	X	X	X
8040	Single end quarter circle	48" ★	X	X	X	X	X	X	X
8015	Double bullnose	48" ★	X	X	X	X	X	X	X
8050	Double bullnose half circle	48" ★	X	X	X	X	X	X	X
8060	Double end quarter circle	48" ★	X	X	X	X	X	X	X

All Starting Steps:

Includes cove moulding to match riser material
 Includes a 1-1/8" tread overhang
 Includes sanded 1-1/16" tread and 3/4" riser.

Please note that 3/4" tread same price, 3/4" not guaranteed on wider than 12-1/2"

★ For lengths greater than 48" there will be an additional charge for every 6" above 48".

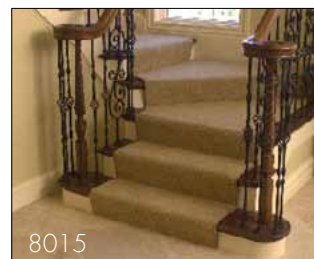
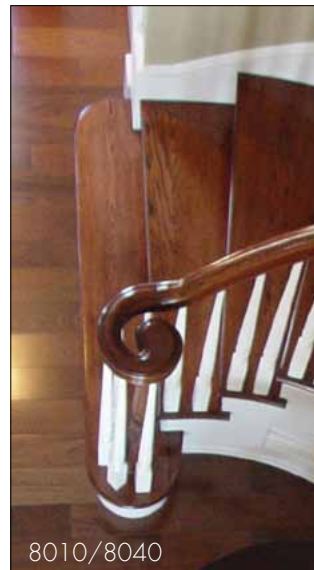
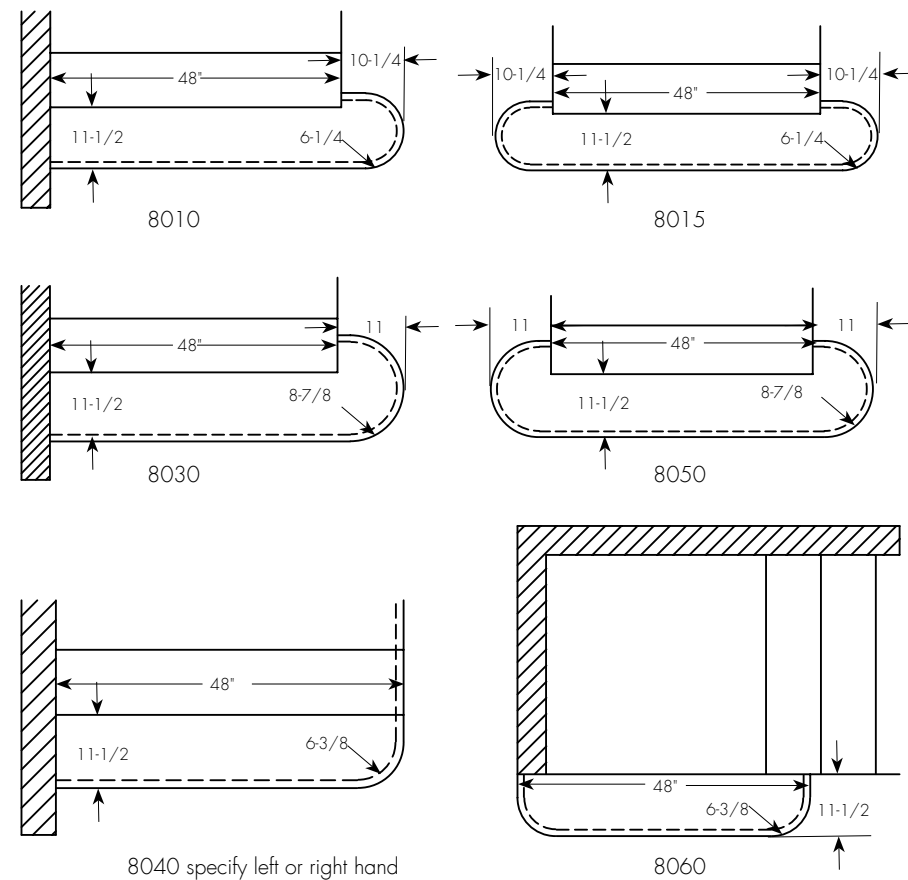

COOPER STAIRPARTS STARTING STEPS

Custom lengths and curves available.

Allow 3 day lead time except where noted.

Part #	Description	Stock	Unit
SHOE10	Quarter Round Shoe Moulding for 8010 Starting Step	X	each
SHOE15	Quarter Round Shoe Moulding for 8015 Starting Step	X	each
SHOE30	Quarter Round Shoe Moulding for 8030 Starting Step	X	each
SHOE40	Quarter Round Shoe Moulding for 8040 Starting Step	X	each
SHOE50	Quarter Round Shoe Moulding for 8050 Starting Step	X	each
SHOE60	Quarter Round Shoe Moulding for 8060 Starting Step	X	each

Cooper Stairworks Stacked Starting Steps - 3 Day minimum

8210	X	Steps combine a standard starting step (#2) and a special starting step (#1)
8240	X	Specify 9" or 10" run measured riser to riser Specify Specie from option above Specify rise, measured from tread to tread No Guarantee for 3/4" tread All options same price, Allow 3 day minimum

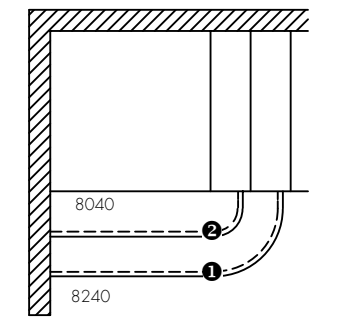
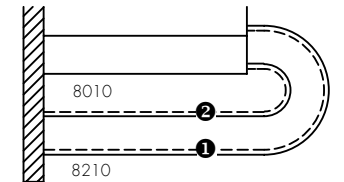

8015

COOPER STAIRPARTS TREADS & RISERS

◆ STOCK X SPECIAL ORDER -- NOT AVAILABLE

TREADS

Size	Length	Oak	Oak with returned end specify L or R	Oak with reversible returned end (Rocky Hill)	Maple	Yellow Pine §	#2 Yellow Pine §	Plywood 3/4" CDX
3/4" x 10-1/2"	x 36"	◆	--	--	--	◆	--	--
3/4" x 10-1/2"	x 42"	◆	◆	◆	--	◆	--	--
3/4" x 10-1/2"	x 48"	◆	◆	◆	--	◆	--	--
3/4" x 10-1/2"	x 60"	◆	◆	--	--	◆	--	--
3/4" x 11-1/2"	x 36"	◆	--	--	--	◆	--	◆
3/4" x 11-1/2"	x 42"	◆	◆	◆	◆	◆	--	◆
3/4" x 11-1/2"	x 48"	◆	◆	◆	◆	◆	--	◆
3/4" x 11-1/2"	x 54"	◆	--	--	◆	◆	--	◆
3/4" x 11-1/2"	x 60"	◆	◆	◆	--	◆	--	◆
3/4" x 11-1/2"	x 72"	◆	--	--	◆	◆	--	--
1-1/16" x 10-1/2"	x 36"	◆	--	--	--	◆	--	--
1-1/16" x 10-1/2"	x 42"	◆	◆	◆	--	◆	◆	--
1-1/16" x 10-1/2"	x 48"	◆	◆	◆	--	◆	◆	--
1-1/16" x 10-1/2"	x 54"	◆	--	--	--	--	--	--
1-1/16" x 10-1/2"	x 60"	◆	◆	--	--	--	--	--
1-1/16" x 11-1/2"	x 36"	◆	--	--	--	--	--	--
1-1/16" x 11-1/2"	x 42"	◆	◆	◆	◆	◆	--	--
1-1/16" x 11-1/2"	x 48"	◆	◆	◆	◆	◆	--	--
1-1/16" x 11-1/2"	x 54"	◆	--	--	◆	◆	--	--
1-1/16" x 11-1/2"	x 60"	◆	◆	◆	--	◆	--	--
1-1/16" x 11-1/2"	x 72"	◆	--	--	◆	--	--	--
1-1/16" x 11-1/2" •	x 60"	◆	--	--	--	--	--	--
1-1/16" x 28" †	x 51"	◆	--	--	--	--	--	--

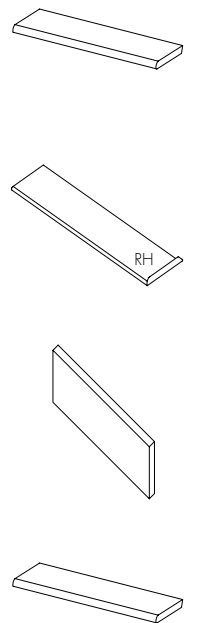

• Good two sides § all yellow pine treads 1" finish thickness † see graphic PAGE 13
Due to varying job site conditions, no manufacturers warranty is available for treads.

Add to any tread for returns by Cooper for sizes not show. Cooper returns coped to match stock return treads. Stock returned treads cannot be tongued.

	Oak	Pine	Maple
Return L or R 1 end	X	X	X
Return L or R 2 ends	X	X	X
Tongue charge to tongue each tread	X		
Groove charge to groove each riser	X		

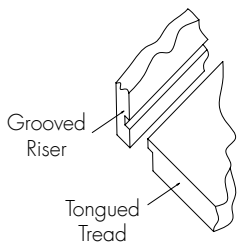

Treads can be returned by the Cooper shop at any length, right, left or both ends. Allow 3 day minimum.

Treads can be ripped to specified width for an additional charge

RISERS

Size ‡	Length	Oak 7-7/8"	Yellow Pine 7-7/8"	Plywood 7-7/8"	Poplar 8"	Poplar 9-1/4"	Clear Pine 9-1/4"	FJ&P Pine 9-1/4"
3/4" x 8"	x 36"	--	◆	◆	--	--	--	--
3/4" x 8"	x 42"	◆	◆	◆	◆	◆	◆	◆
3/4" x 8"	x 48"	◆	◆	◆	◆	◆	◆	◆
3/4" x 8"	x 54"	◆	◆	◆	◆	◆	◆	◆
3/4" x 8"	x 60"	◆	◆	◆	◆	◆	◆	◆

‡ Nominal height. See exact height under specie in this chart.
Almost any species and tread or riser length available by special order. Ask your sales representative for details.

COOPER STAIRPARTS PREMIUM SPECIE / WINDER TREADS

◆ STOCK X SPECIAL ORDER -- NOT AVAILABLE

Plain treads are square three sides and nosed one edge with a sanded face. Risers are S4S with a sanded face.

Part #	Size	White Oak	Cherry	Jatoba
1-1/16" x 10-1/2"	x 36"	X	X	X
1-1/16" x 10-1/2"	x 42"	X	X	X
1-1/16" x 10-1/2"	x 48"	X	X	X
1-1/16" x 10-1/2"	x 54"	X	X	X
1-1/16" x 10-1/2"	x 60"	X	X	X
1-1/16" x 10-1/2"	x 72"	X	X	X
1-1/16" x 11-1/2"	x 36"	X	X	X
1-1/16" x 11-1/2"	x 42"	◆	X	X
1-1/16" x 11-1/2"	x 48"	◆	X	X
1-1/16" x 11-1/2"	x 54"	◆	X	X
1-1/16" x 11-1/2"	x 60"	X	X	X
1-1/16" x 11-1/2"	x 72"	◆	X	X

Available Per Set	Oak		"C" Southern Yellow Pine	
	42"	48"	42"	48"
Standard 30° layout	◆	◆ 3WND48O	X	X 3WND48P
Standard 45° layout	◆	◆ 2WND48O	X	X 2WND48P
Custom layout 3 treads	X	X	X	X
Custom layout 2 treads	X	X	X	X
Oak Panel Blank (1-1/16" x 28" x 51")	◆	X		

Specify Hand Left or Right

Tread thickness is 1-1/32" with a tolerance of plus or minus 1/32". Riser thickness is 3/4" with a tolerance of plus or minus 1/32". Call for special quote for CLEAR grade pricing on wood species.

2 Winder Set

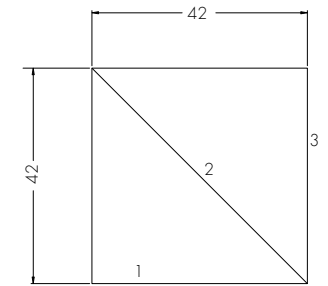

45° Right Hand

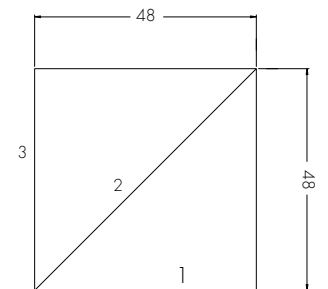

45° Left Hand

3 Winder Set

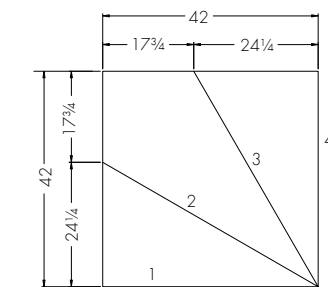

30° Right Hand

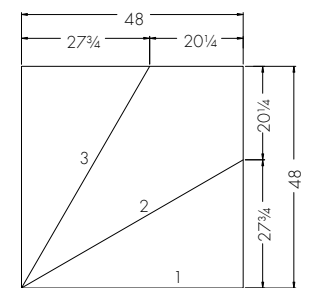

30° Left Hand

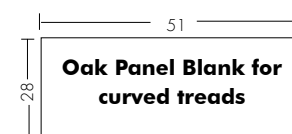

Custom winder treads require templates and will be made 2" oversize. Allow 3 days.

Winders are available 3/4" thick at same price. 3/4" thick winders over 8.75 sq.ft. not guaranteed.

ASK ABOUT OUR PREASSEMBLED STAIRS AND PRE-FIT RAIL SYSTEMS

COOPER STAIRWORKS pre-fit rail systems are shop fitted to Cooper preassembled stairs. The combination of these two products eliminates countless hours of on-site carpentry and assures that the final product will be constructed using time tested stair building techniques and the best quality materials available. The use of our staircase products will help you maintain design integrity at substantial savings over other methods. Add value to your next project, incorporate our high quality and expertise, specify Cooper Stairworks.

5 YEAR WARRANTY



PRE-FIT RAIL SYSTEMS



Post is notched for exact location and height.



Stair is notched for post and treads drilled for balusters.



One end of rail is precut for quick field installation with post to post rail systems. Opposite end is cut to fit in field.



Cooper Pre-fit Rail Systems combined with our preassembled stairs enable you to realize many cost efficiencies. No more questions on what parts to use? Where to find them? How they go together? Simply select any stock or custom style balustrade. Our professional stair builders will configure the correct parts and prefit them to your stair while it is in our shop.

Pitch rails on stair are drilled for easy baluster insertion up into rail and down into tread.



FREQUENTLY ASKED QUESTIONS

When do I start?

Contact us at the beginning of the design phase. This is when you have the most options available and our expertise can be most helpful. We will meet your design requirements and value engineer your project. The longer you wait the more you limit your options or create unusual and costly framing changes.

How do I start?

Fax us a copy of your plans in the area of the stair at each level and provide the height from floor to floor. You may request literature or view our website for our offerings to consider your rail and baluster preferences. Our Stair "Facts Fax" form is available on the following page, online or we can fax a copy to guide you through the planning process. We will send you a quotation for the complete stair system with your choice of balustrade or one we have recommended to meet your budget.

How do I order?

Simply approve the quotation. We will finalize the details and send a contract for you to sign. A shop drawing will follow for approval and if you are within reach of our serviced areas, a field technician will confirm field dimensions. If you have purchased a curved stair system we provide the curved wall plates, curved floor templates and a positioning diagram to coordinate the fit of the stair system while framing. This allows you to complete most of the framing and wall finish prior to taking delivery of the stair and rail system.

When does the stair arrive?

Once the job is weather tight, the stair and rail system will be delivered. The stair will be wrapped with six-mil polyethylene wrap and tread guards will be applied to protect the stair from jobsite traffic. When ready the protective wrap can be turned back and the rail system unpacked and applied.

We also offer complete installation in our service area. See your Sales Representative for details.

Please photocopy & fax to the number below or GO TO OUR WEBSITE TO FILL OUT THIS FORM ONLINE || www.cooperstairworks.com/preStairs.htm



"Stair Facts Fax" QUOTATION FORM

Date: _____

Sales#: _____

Acct#: _____

Name _____ Co. Phone _____

Co. Name _____ Co. Fax _____

Co. Address _____ Job Name & Location _____

Email _____ Do you have an account with us? Yes No

PLEASE SELECT CATEGORY: Homeowner Residential Builder Commercial Builder

Lumberyard Architectural Firm Remodeler

Number of homes you build per year? 1 - 5 6 - 12 13 - 30 over 30

Have you ever used preassembled stairs before? Yes No

STAIRCASE MATERIALS (Circle One):

	ECONOMY (#SYP)	CARPET Structure Treads	CELLAR SYP Treads	CARPET SYP Treads									OTHER
Risers	DSY P	CDX	D SYP	D SYP	C SYP	D SYP	C SYP	POP	OAK	C SYP	POP	MAPLE	
Tread	#2 SYP Stepping	Structure Tread	#2 SYP Laminated Tread	#2 SYP Laminated Tread	C SYP	OAK	OAK	OAK	OAK	MAPLE	MAPLE	MAPLE	
Stringer	D SYP	C SYP	D SYP	C SYP	C SYP	D SYP	C SYP	POP	OAK	C SYP	POP	MAPLE	
Cove	NONE	NONE	NONE	NONE	C SYP	D SYP	C SYP	POP	OAK	C SYP	POP	MAPLE	

ALL OPEN TREADS TO BE BULLNOSED

ALL OPEN TREADS HAVE MITERED RETURNS

#2 SYP STEPPING & STRUCTURE GRADE TREADS ARE NOT TONGUE & GROOVED

PRE-FIT RAIL SYSTEMS:

	PART NUMBER	STYLE (fluted, plain, etc.)	MATERIAL (oak, beech, etc.)
Baluster			
Newel			
Rail			

Handrail Type (check one)

Post to Post

Over the Post

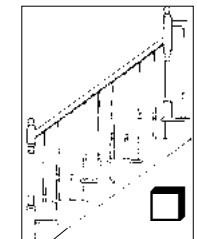

CURRENT STAGE OF PROJECT: (CHECK ONE) Blueprint Rough framed Finish plaster

Finishing - Would you like quote to include:

Priming of stringers & risers (includes backspray of stairs) Yes No

Sanding sealer applied to treads Yes No

Priming of Balusters Yes No

Additional Information:

PREFINISHING

With our finishing line we can easily prime any paint grade stairparts. We can also provide a clear sealer coat on tread material. Saving both time and money, our prefinishing options will bring you one step closer to the final finishing process.



LEARN ABOUT OUR OTHER STAIR AND CUSTOM MILLWORK PRODUCTS

For more information on these products visit us online at www.cooperstairworks.com or call us at 508.235.4397.



Cooper Stairworks

Explore our Cooper Stairworks catalog featuring our preassembled stairs and pre-fit rail systems. Learn the anatomy of a stair and see how a preassembled stair is built. Includes stunning photography of Cooper Stairs along with CAD drawings.



Spiral and Attic Stairs

We are proud to distribute a full line of metal and wood spiral stairs as well as attic stairs.



Fitts Stair Parts

For more than a half century the Fitts name has been associated with quality in the woodworking industry. Fitts manufactures more than 6000 different stair parts in virtually any wood specie and wrought iron.



Captiva Custom Wood Doors

Complement your staircase with beautiful Captiva wood doors. Each door is custom made to your exact specifications.



Tech Support 508.235.4397

Distributed by: